

#### PLEASE NOTE -

The audio player for this chapter sample ( see lower right sidebar ) is the embed player provided by Spotify. By default, it will only play a 30 second preview of each song, taken randomly from the middle of the song track. To hear the full tracks from the beginning, you must log in with a free Spotify account, then come back and refresh this page. This is important, because most of the musical elements being discussed occur at or near the start of each song. For ad-free listening you will need a Spotify Premium account.

Unfortunately, Spotify does not provide full tracks when you use their embed player with iPads or Safari. For this reason, you will need to use a laptop or desktop with either a Firefox, Chrome, or Edge browser to hear the full songs.

The audio player provided in the paid version of Spinning Gold is a much-improved CUSTOM AUDIO PLAYER, built exclusively for this website. It will always play the full song on any laptop, desktop, or tablet with all major browsers. The custom player also has a larger progress bar and larger time-elapsed number. This will allow easier navigating within the track when discussing musical elements that occur in the middle of the song.

Also note that the audio playlist only includes songs in the sample pages, and is not the full playlist from the paid version. Therefore, the playlist track numbers may not match up with the track numbers in the sample pages.

## CHAPTER 4



# THE BLUES

## Major meets Minor



You may have heard the saying “The Blues Had a Baby and They Called It Rock n’ Roll.” There is much truth to that old phrase. The blues has influenced many forms of American popular music, including gospel, jazz, country, and rock styles, which have now morphed into the myriad of genres present in today’s digital landscape.

Blues music may be considered basic and unadorned in some circles, but understanding blues in terms of standard music theory can be a difficult task. Our Western European tonal system is based on two pillars — major and minor. Blues basically exists between the cracks of major and minor, so traditional music theory is sometimes inadequate. This should not be surprising, for blues does not come solely from the European tradition. If you go back far enough, blues is actually a **blending of the European and African traditions**, representing a combination of British folk ballads with African-American worksongs and spirituals.

### Essential Concepts / Skills covered in chapter 4

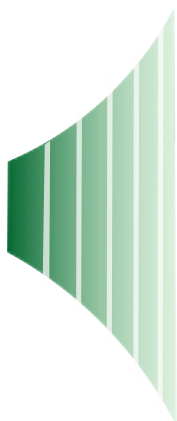

- Blues scales, dom 7th chord, blue notes, vocal melisma
- Blues origins, cover songs
- Common chord progressions, especially the 12-bar blues form and its variations, as heard in pop song examples
- Signature riffs, boogie bass patterns, turnaround riffs
- Songwriting devices for creating focal points
- Ear training - I7, IV7, V7, chords

In terms of traditional music theory, there is no “official” 7-note blues scale, and no set of diatonic chords generated from the scale as with the major and minor keys. Instead, blues features a tonal mixture, most commonly using minor pentatonic melody notes over major triads I, IV, and V. This clash of minor over major, specifically the **flat 3rd scale degree in the melody** against the **natural 3rd note in the I chord**, is what give blues its unique harmonic sound.

Here’s an example of the blues sound in a pop/rock hit from 1965, illustrating the clash between melody and chords. The notes of the I chord are Eb, G, and Bb (scale degrees 1, 3, 5), and there is also a Db (b7) note, that gives additional blues flavor (more on the b7 later). **START LISTENING AT 0:52.**

**"She's About a Mover" – Sir Douglas Quintet – 1965**

Eb blues



For AUDIO, see the “Song Examples” playlist in the right sidebar, and click on track 1 song title. To navigate within the audio track, slide the progress bar forward or back to the desired starting point.

**0:52 CHORUS**

*Eb*                      **minor pent. melody with FLAT 3rd note (Gb)**

she's a - bout a mov - er

**I chord with NATURAL 3rd note (G) . . . . .**

## Origins of the Blues

As mentioned, although blues does not fit neatly into the Western European tonal system, it does borrow several basic elements from that tradition. The overall song form is taken from British folk songs and hymns, including the use of metered rhythm, with 12 or 16-bar verses, and 3 or 4-line lyric phrases. The I, IV, V chord accompaniment is also derived from Western harmony, not African music. In fact, for much of traditional African music, there is no harmony at all.

In terms of rhythm, the blues probably shows more African than European influence. In African tradition, rhythm is paramount, with some African pieces having neither harmony or melody — just drum ensembles playing very complex, non-metered polyrhythms. Western tradition has few, if any true polyrhythms, but the importance of syncopation (off-beat accents) in American blues, jazz, and eventually rock is often considered an echo of distant African beats.

Cultural differences also contribute to the contrast between blues and European music. For several centuries, European culture has been transmitted through the written word, while African culture is based on an oral tradition. This is reflected in the importance of the written score in European music, versus improvisation in African music. Trying to notate blues melodies can be quite frustrating, thanks to the use of unique pitches known as “**blue notes**,” which don’t conform to standard European notation.

### BLUE NOTES

Going back to the days of slavery and spirituals, African-American singers would modify the melodies to European hymns and folksongs, reflecting the different scales and sounds they carried from their African homeland. (Traditional African music is sometimes based on dividing the octave into 7 equal parts, unlike the 12 pitches we use in Western European tradition.) The most common notes to be altered were the 3rd, 5th, and b7 degrees, by sliding into each note from a half step below. Sometimes the slide would be as large as a whole step to the 3rd or 5th, creating a wide area of pitch ambiguity between the 2 and 3 and the 4 and 5.

At the turn of the 20th century, these blue notes were especially prominent in African-American **field hollers and worksongs**, two types of music that contributed substantially to the development of early blues. Here is an example of a field holler, recorded by researchers in rural Alabama in 1950. The numerous **pitch bends** and **slides** are mainly between the 2nd and 3rd degrees.

***Children's Call" – Annie Grace Horn Dodson – 1950***

A blues



Over the years, blue notes gradually became an indelible part of virtually all American folk and pop — from blues and jazz, to R&B, gospel, and rock. These pitches are even prevalent in styles not usually associated with blues, such as country, bluegrass, and even Broadway show tunes.

A modern example of blue note singing can be heard on Eric Clapton's 1994 album *Blues from the Cradle*. Listen to how Clapton sings the word "ground" on the blues classic "I'm Tore Down," letting the pitch drift upward from the **flat 3rd** (Eb note in the key of C) towards the **natural 3rd** (E note).

***"I'm Tore Down" – Eric Clapton – 1994  
(orig. Freddie King)***

C blues



0:08 VERSE

swing

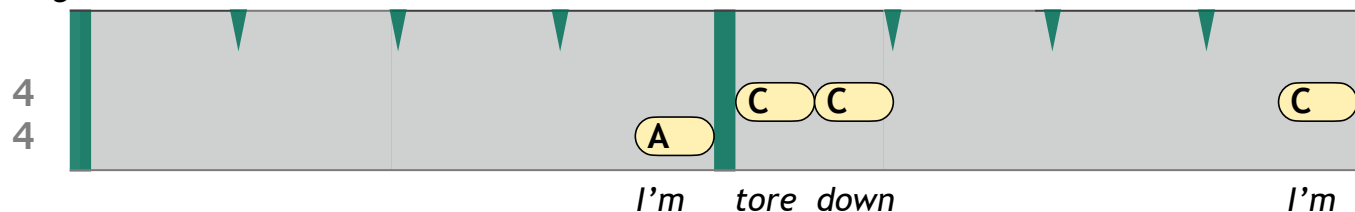

BLUE NOTE

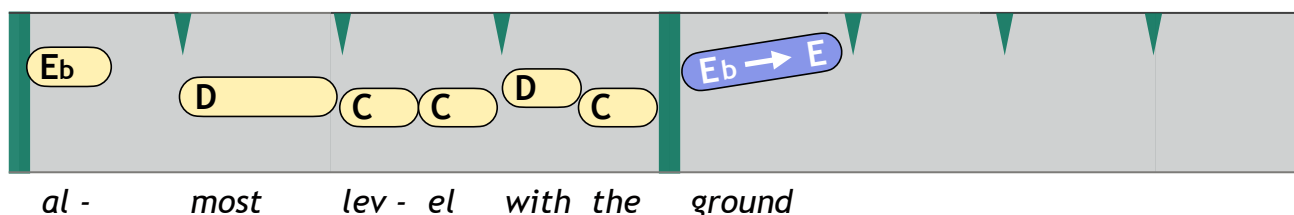

The note on “ground” is somewhere between E flat and E natural. It seems to rise up, so it is written in our alternative graphic notation as slanting upwards from left to right, as shown above. In traditional staff notation, there would be a slur mark written between the two notes of Eb and E. Either way, it is obviously difficult to capture blue notes in written notation.

Let’s check out another example of blue notes, this time from Bonnie Raitt. Listen to how she sings the word “wanted.” START LISTENING AT **0:22**

**"Come to Me" – Bonnie Raitt – 1991**

**D blues**  4

**0:22 VERSE** **BLUE NOTE**

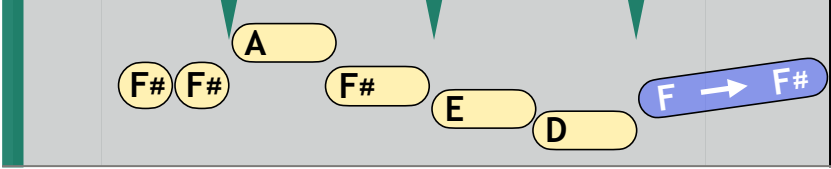

All I e - ver want - ed \_\_\_\_\_

Again we have problems trying to capture the singing in notation because the blue note on “wanted” falls somewhere between the pitches of F natural and F sharp. Many pop & rock songs contain blue notes, so we must remember that these melodies are best learned by ear rather than printed score.

Since blue notes originated with the voice, they are also quite difficult to imitate on a fixed-pitch instrument like a piano — you have to either trill between 2 notes or simply crush them together. This is why pop & rock vocal melodies can sound too formal or “stilted” when played on a piano alone. The guitar, however, is ideally suited for blues, thanks to the magic of string bending. In fact, it has always been the highest compliment to say that a blues guitarist can really make his instrument “talk” ( think of B.B. King and his beloved guitar “Lucille”).

In our last example for this section, we’ll listen to blue notes on guitar, but with a twist. The pitches are bent by sliding a metal bar across the top of the strings — better known as “**slide guitar**.” This technique is also a part of the blues tradition, and the style was carried

into the rock era by blues rock bands like Lynyrd Skynyrd, ZZ Top, and The Allman Brothers. In “Statesboro Blues” listen to how Duane Allman makes his guitar “talk,” answering the short vocal phrases of brother Gregg, STARTING AT **0:39**. This **vocal call / instrumental response** is a hallmark of the blues style.

**“Statesboro Blues” – Allman Brothers Band – 1971**  
(orig. Blind Willie McTell)

D blues



- **0:46** (verse) **Call & response** “dialogue” between vocal & slide guitar
- **1:32** (guitar solo) Exaggerated **BLUE NOTES** especially at **1:39**

(Pages 7 & 8 omitted from this sample)

## DOMINANT 7th CHORDS

It was mentioned earlier that the basic accompaniment in blues harmony consists of the I, IV, and V major triads. However, in the blues style these will often be 4-note chords instead of triads, adding the b7 note to create what are called **dominant 7ths**. (The word “dominant” is usually omitted from the chord symbol.) This addition of the b7 was briefly mentioned earlier when listening to the song “She’s About a Mover.” Some blues may have all triads, some all 7ths, and some a mixture of the two. The formula for the C7 chord is shown below.

**ex.1**

For AUDIO, see “Theory Examples” on top-right sidebar, and click on ex. 1

C                    E                    G                    B $\flat$                     C $\flat$

1                    3                    5                    b7                    =                    C dom 7th

Two notes inside the structure of the C7 chord, E and Bb, form a special interval known as a **tritone**. The distance from E to Bb could be considered a diminished 5th, with E as the 1 and Bb as the b5. Remembering from Chapter Two that A# is another way to spell the Bb note, it could be called an augmented 4th, with E as the 1 and A# as a #4. Either way, the simplest way to describe a tritone is the 3 and b7 notes of a dom7 chord.

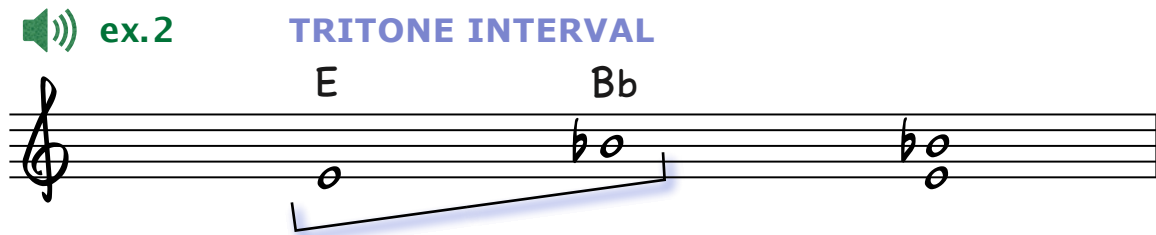

This distinctive interval has an arresting sound — so arresting that it is included in the blaring notes of a traditional train whistle. In the European Renaissance, Baroque, and Classical periods it was considered to be a dissonance best avoided. However, it is embraced as a signature of the blues sound. The tritone gives the dom 7th chord its unique, “edgy” sound, and the interval is often isolated and prominently featured in blues accompaniments and solos.

## WRITTEN EXERCISE

Practice spelling some common dominant 7th chords by completing **Exercise 4.1** (see “Textbook Contents”/ “Volume 1”/ “Written Exercises”).

## BLUES COVERS

In addition to borrowing individual elements like blue notes, melisma, and dom 7th chords, many pop & rock artists have hit the charts by covering (re-recording) entire songs from the blues repertoire. You may have noticed previously on the green title bars that both “I’m Tore Down,” and “Statesboro Blues” were cover songs, done originally by Freddie King and Blind Willie McTell respectively.

Sometimes the cover version is intentionally similar to the original, as the modern performer simply wants to pay respectful tribute to the bluesman’s work. “I’m Tore Down” clearly falls in this category, as Eric Clapton’s cover faithfully reproduced Freddie King’s lyrics, melody, rhythmic feel, and even several of Freddie’s guitar licks



(Pages 10- 12 omitted from this sample)

In other recordings the cover is done radically different, as on the earlier slide guitar example “Statesboro Blues.” On that song the Allman Brothers transformed Willie McTell’s gentler, acoustic original (recorded in 1929) into a driving, southern-rock shuffle, complete with two drummers and lengthy electric solos. In the early 1970s the Allmans modified several other blues originals, including Muddy Waters’ “Hoochie Coochie Man,” and Sonny Boy Williamson’s “One Way Out.”

Iconic British rock band Led Zeppelin specialized in covers, recording well over a dozen blues songs in the 1970s, including their first chart hit “Whole Lotta Love,” which was based on Muddy Waters 1962 song “You Need Love.” On most of their covers, Led Zeppelin chose to substantially re-work the originals, often transforming a relatively simple pre-war blues song with acoustic guitar into a full-blown production of arena rock.

This transformation is perfectly illustrated on Led Zeppelin’s 1971 recording of “When the Levee Breaks.” The song was originally recorded in 1929 by Memphis Minnie and Joe McCoy. Listen first to the original, noting the **fast tempo and delicate, jangling guitars** playing major I, IV, V chords, which create an upbeat mood. This is curiously at odds with the minor pentatonic blue notes in the melody, and the dark subject matter of the lyrics.

***“When the Levee Breaks” — Memphis Minnie — 1929  
& Joe McCoy***

Bb blues



Led Zeppelin’s cover version - drenched in heavy reverb with low, rumbling bass, massive drum beats, and high, menacing harmonica notes - created a foreboding atmosphere few rock fans will forget. As Robert Plant sang “If it keeps on rainin’ the levee’s

going to break,” it is not hard to imagine the black storm clouds rolling in. Group guitarist Jimmy Page has stated in interviews that their version is almost unrecognizable from the original, for he wanted to make the song sound as ominous as possible. Most would agree that the group succeeded. Notice that unlike the previously heard covers, this recording is decidedly slower than the original.

**"When the Levee Breaks" – Led Zeppelin – 1971**

F blues



- **0:00** The recording opens with a **heavy, propulsive drum beat**.
  
- **0:07** A **high, shimmering harmonica** enters with an **arresting tone**, playing notes that sound like a train horn.  
  
Underneath, the bass and guitar play a **low, rumbling riff**, based on the **dark- sounding b3 to 1 notes**. This adds a menacing touch to the song. The mood is ominous.  
  
There is no chord “progression,” just **one single chord** acting as a **hypnotic drone** over the first minute of the song
  
- **1:08** The chords briefly change and a **swirling guitar** slides between each chord, adding to the **trance-like** feeling.
  
- **1:24** (verse) - Vocals enter as the song settles back to the single droning chord.

This musical transformation from original to cover version is due mainly to differences in something called **timbre** - ie. tone quality. Timbre can be described in terms of “bright” vs. “dull” or “smooth” vs. “rough,” but it should not be confused with pitch, which describes “high” vs. “low.” For example, the middle C note on a piano is a specific pitch. Yet that same exact pitch (same octave) could be played on a clarinet, flute, or trombone. It is the unique tone or timbre that would allow us to identify each instrument.

## A WORD ABOUT TIMBRE

While traditional musical analysis often focuses on the elements of rhythm, melody, harmony, or form, the element of timbre is sometimes overlooked. Timbre is crucial to the overall presentation of a song. In symphonic music, the composer gives careful consideration to which combination of instruments will play a specific part.

Although rock bands typically have fewer instruments than an orchestra, timbral creativity in pop music is just as important (if not more so) than in classical music. With the advent of electronic effects and the synthesizer in the late 60s, musicians can now create completely new timbres that go beyond the sound of traditional instruments. Rock guitarists have been known to spend hours and hours experimenting with the array of effects pedals at their feet, trying to find just the right sound for a song. In the studio, more time is often spent on mixdown and production than actually writing melodies and chord progressions. In fact, advances in audio technology have basically transformed the modern recording studio into another instrument and the sound engineer into another performing musician.

When we listen to many pop & rock songs of the last 70 years, it is clear that the creative interest is not always in the melody or harmony of these songs. Many classic hits have a **weak “melodic ID”** - ie, a narrow, blues-based melody that pivots around the same two or three notes for the entire song. If only the melody line is played on a single piano, it would be hard for most listeners to distinguish the difference between Led Zeppelin’s “Heartbreaker,” Elvis’s “Jailhouse Rock,” Lynyrd Skynyrd’s “Sweet Home Alabama,” Tim McGraw’s “Down on the Farm,” or Def Leppard’s “Let’s Get Rocked.”

In terms of chord progressions, there are also many well-known songs that have a **weak “harmonic ID,”** based on only one chord throughout the entire song. These include diverse hits like Kool & The Gang’s “Jungle Boogie,” David Bowie’s “Fame,” George Thorogood’s “Who Do You Love,” Harry Nilsson’s “Coconut,” and the recent hit “Bang Bang” from Jessie J, et.al. - not to mention all the one-chord minor key songs listed previously in Chapter Three. In many of these songs, as well as the cover songs discussed above, the interest lies mainly in the rhythm and especially in the timbre.



(Pages 16 & 18 omitted from this sample)

## Project for Further Study & Discussion

Choose a song from the “Additional Listening” list “**BLUES COVERS that TRANSFORM the ORIGINAL**” (shown above).

- Describe how the cover version differs from the original in terms of overall style & feeling.
- Describe differences in specific musical elements like rhythm, tempo, form, instrumentation, timbre, melody, or lyrics.
- Was a repeated riff added on the cover version?
- Which version do you like better?

### **BLUES SCALES and IMPROVISATION**

As mentioned in Chapters Two and Three, the numerous song examples and “Additional Listening” lists throughout this book provide lots of raw material for practicing improvisation, since key info is listed for every song. Chapter Two briefly discussed using the major pentatonic scale as a starting point for improvising solos with the major key songs, and Chapter Three suggested using the minor pentatonic on the minor key songs.

However, a detailed explanation of scales and improv is beyond the scope of this book. Players will want to consult the supplemental guitar workbook that accompanies this main text for much more in-depth information. The workbook includes discussions about phrasing and technique, along with suggested riffs and how to play some of the famous “signature riffs” included in the main text. For now, we will include here only a brief discussion of some scale choices for blues improvising.

As mentioned earlier, there is no “official” 7-note blues scale, and no set of diatonic chords generated from the scale as with the major and minor keys. Blues melodies and riffs are often based on some version of the **minor pentatonic** scale, although the basic chords are I, IV, and V borrowed from the major key. This sets up the unique tonal mixture of major and minor. However, blues improv can also be approached from the major side, starting with the **major pentatonic** scale and then adding occasional b3 or b7 notes for a bluesier sound. You can even use both pentatonics in the same song, such as the major over the I and V chords, and minor over the IV. (Jazz players are used to following the chord changes like this, and they often go one step further - playing embellished dominant 7th arpeggios to match each chord).

(Pages 20 &amp; 24 omitted from this sample)

## WRITTEN EXERCISE

To practice spelling some common major pentatonic scales with the added  $b3$  note, try **Exercise 4.3** (see “Textbook Contents”/ “Volume 1”/ “Written Exercises”).

## TWO CHORD VAMP, I7 – IV7

Several pop & rock songs are based on a simple two-chord vamp alternating the I7 and IV7 chords. In the diagram below, written in the key of C, you will notice that the  $b7$  note of the IV7 chord (placed on the top of the chord) is the  $b3$  of the overall key. Since the natural 3rd is in the I chord (also placed on top for clarity), this means that vamping between I7 and IV7 creates a half-step **alternation between 3 and  $b3$  of the key**, once again underscoring the **major - minor ambiguity** of the blues.

top note movement — e  eb  e



chord name — **C7** **F7** **C7**  
I7 IV7 I7

Brenda Lee’s 1961 recording “Dum Dum” is a perfect example of a song based on the I7, IV7 vamp. (Well, almost perfect - there is a very brief V chord at the end of each verse.)

**“Dum Dum” — Brenda Lee — 1961**

Db blues



Here’s a more recent example of the vamp. The repeated guitar riff once again features the bluesy  **$b3$  - natural 3 ambiguity**:

**"Hooch" – Everything – 1998**

B blues



0:00 REPEATED RIFF

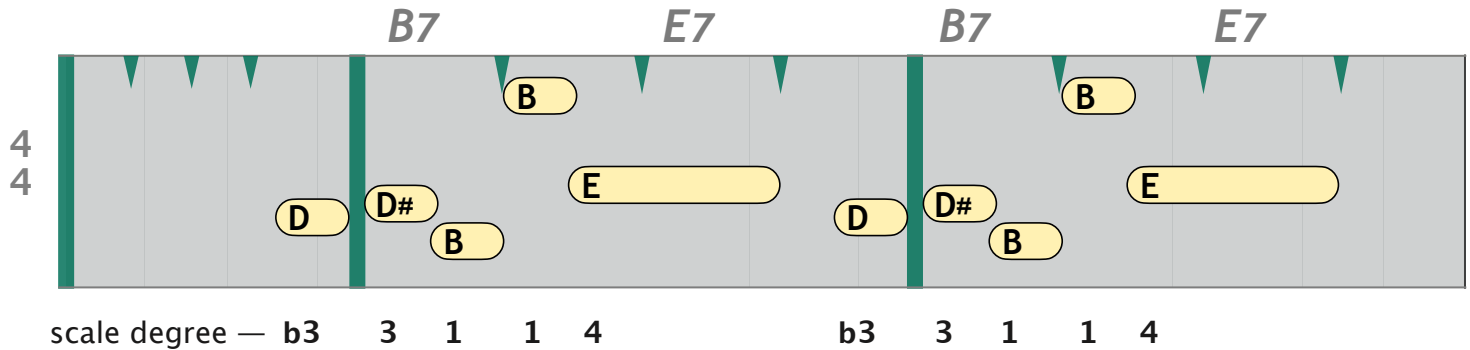

Looking back at the diagram of the I7 - IV7 chord change, a closer look reveals that another pair of notes, Bb and A, also move by half step. If combined with the E and Eb notes, it becomes apparent that these are the tritones of each chord, moving seamlessly back and forth by half step. This gives the I7 - IV7 vamp a distinct and bluesy sound. To get a stronger blues flavor, the guitar or piano sometimes play only the tritone notes, letting the bass guitar add the chord roots.

**HALF STEP TRITONE MOVEMENT**  
C7 and F7 chords

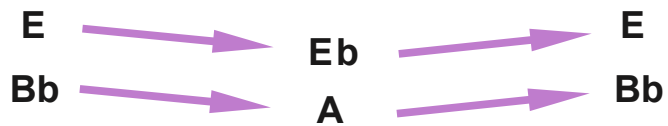

This close movement between the tritones of the I7 and IV7 can be heard on Animotion's 1985 dance hit "Obsession," where a repeated guitar riff basically outlines the tritone intervals of each chord. **START LISTENING AT 0:33**

**"Obsession" – Animotion – 1985**

D blues



0:33 TRITONE RIFFS

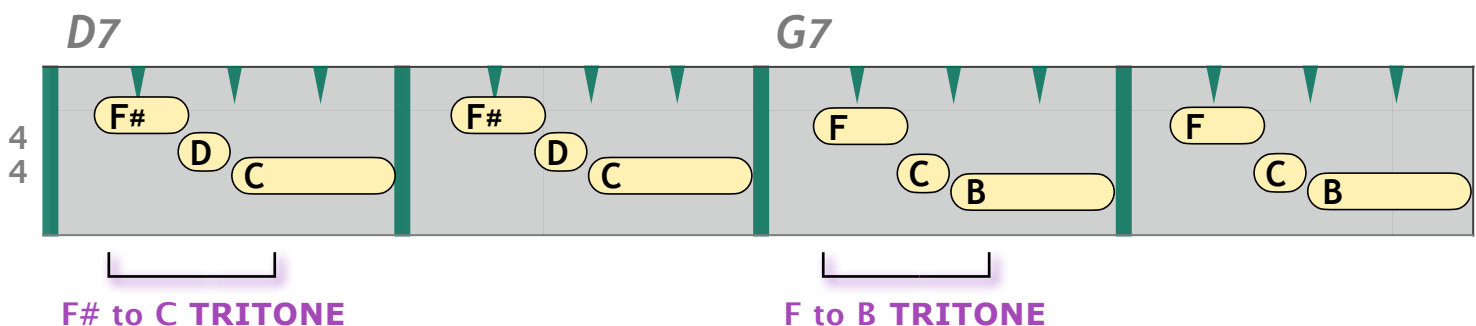

## Additional songs with TWO CHORD VAMP I 7 – IV 7 (blues)

1986	<i>To Be a Lover</i>	Billy Idol	C blues
1991	<i>Things That Make You Go Hmm</i>	C & C Music Factory	Eb blues
2001	<i>Love You Madly</i>	Cake	E blues

### 12-BAR BLUES FORM

Many pop & rock songs with a blues tonality follow the **traditional blues form**, consisting of a repeated 12 bar verse, divided into 3 lines of equal length. Each 4-bar line has a vocal phrase of 9 beats, often followed by an answering instrumental phrase of 7 beats. The vocal phrases are usually done in an A, A, B sequence, accompanied by I, IV, and V chords as either triads or dominant 7ths. A very basic version of the form is shown below.

#### BASIC 12-BAR BLUES

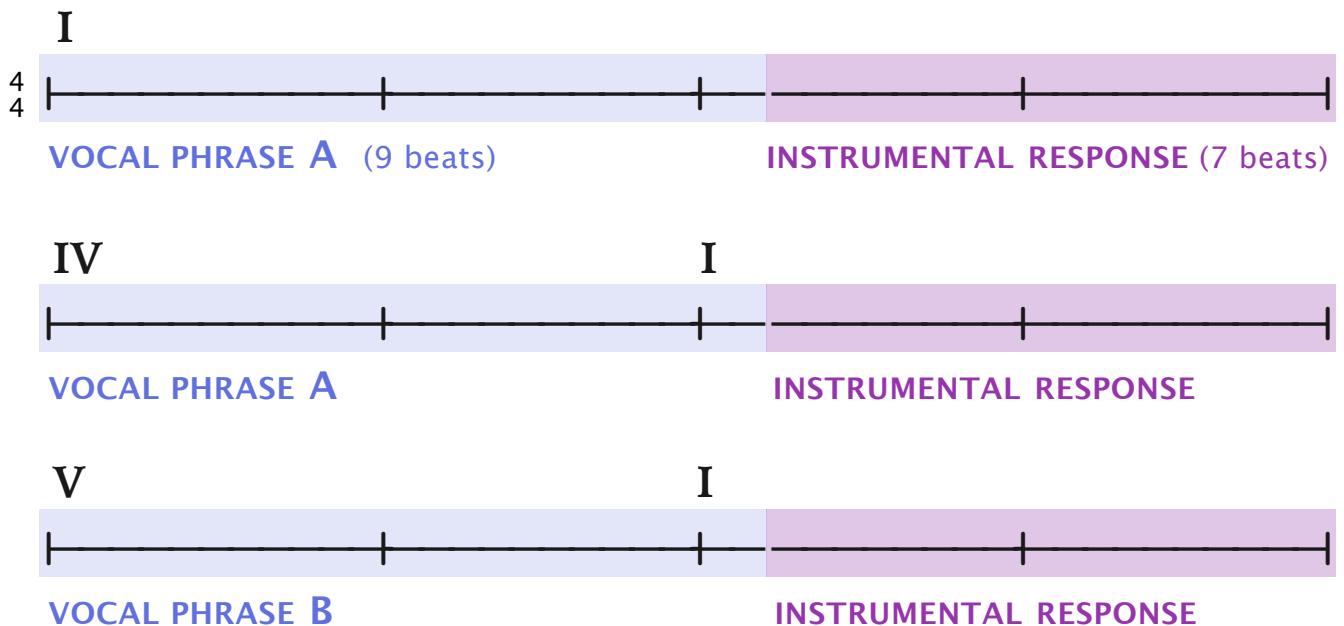

Often the chord progression is varied to include occasional dom 7ths and the **IV chord** on bars two and ten (circled below).

### 12-BAR BLUES chord variation

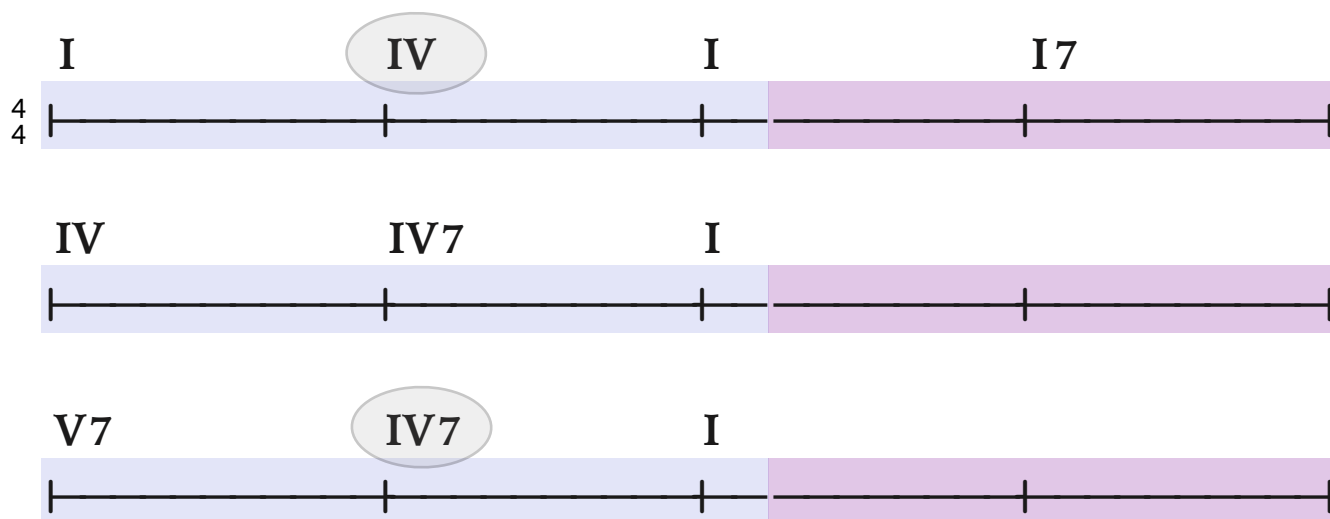

## WRITTEN EXERCISE

Practice writing some 12 bar blues progressions in different keys by completing **Exercise 4.4** (see “Textbook Contents”/ “Volume 1”/ “Written Exercises”).

The 12-bar blues form can be a short, ready-made formula for beginning songwriters, yet it has plenty of room for creative improvisation within the fairly narrow structure. Virtually all musicians playing popular music know this form backwards and forwards. This creates a sort of universal language that enables musicians who have never performed with each other to get up on stage, without rehearsal, and “jam” as though they have played together for years.

Stevie Ray Vaughan’s 1989 recording “Let Me Love You Baby” is a perfect example of the basic 12-bar form outlined above, with **A, A, B lyric structure**, and clear **call & response phrases** of 9 and 7 beats respectively. The only difference is the addition of the IV chord on bar 10 and the V chord on the last 2 beats of bar 12. **START LISTENING AT 0:22**



**"Let Me Love You Baby" – Stevie Ray Vaughan – 1989**  
(orig. Buddy Guy)

E blues



0:22 VERSE

I

4  
4

Ooo - wee baby, I declare you sure look fine

GUITAR RESPONSE RIFF (7 beats)

IV

I

Ooo - wee baby, I declare you sure look fine

GUITAR RESPONSE RIFF

V

IV

I

V

A girl like you made many-a man change his mind

GUITAR RESPONSE RIFF

(Page 30 omitted from this sample)

The 1960s featured several instrumental hits with the 12-bar form and blues tonality, including Sam The Sham & The Pharaohs' "Wooly Bully," The Surfaris' "Wipeout," and the next example "Last Night." On this song all chords are dom 7ths.

**"Last Night" - Mar-Keys - 1961**

F# blues



In pop & rock music the 12-bar form is sometimes **"doubled"** to 24 bars, with the I, IV, and V chords retaining the same proportions within the form. This translates to 8 bars of I, then 4 bars of IV, I, V, and I. Here's an example from Lynyrd Skynyrd of the doubled form:

**"Swamp Music" - Lynyrd Skynyrd - 1974**

E blues



## Additional songs with 12-BAR BLUES FORM

1957	<i>Send for Me</i>	Nat King Cole	F blues
1962	<i>Peppermint Twist</i>	Joey Dee & The Starlites	C blues
1965	<i>She's About a Mover</i>	Sir Douglas Quintet	E $\flat$ blues
1970	<i>Mississippi Queen</i>	Mountain	E blues
1971	<i>Statesboro Blues</i>	Allman Brothers Band (orig. Blind Willie McTell)	D blues
1980	<i>Sweet Home Chicago</i>	Blues Brothers (orig. Kokomo Arnold)	F blues
1983	<i>She's Sexy and Seventeen</i>	Stray Cats	E blues
2019	<i>Don't Threaten Me with a Good Time (start at 0:21)</i>	Thomas Rhett feat. Little Big Town	E $\flat$ blues

(Pages 32 - 43 omitted from this sample)

## EAR TRAINING EXERCISES

For additional practice hearing the I, IV, V and I7, IV7, V7 in a blues tonality, try **Exercises 4.1e - 4.5e** (see "Textbook Contents" / "Volume 1" / "Ear Training Exercises").

## Boogie Bass Patterns

### BASS ALTERNATING 5, 6

Many rock songs are anchored by a particular kind of harmonic riff called a **boogie bass**. The most common version features the 5th and 6th degrees of the chord at hand, alternating over the root, as shown in the example below from the 12-bar hit “Keep Your Hands to Yourself.” The rhythm is almost always a steady stream of 8th notes with the short pattern repeating every 2 beats. This pattern shifts to match the chord changes, like the previous bass patterns in Chapter Two (“Ain’t That a Shame,” “Haunted House,” “Can’t Turn You Loose”), or Harry Nilsson’s “Early in the Morning.”

*“Keep Your Hands to Yourself” - Georgia Satellites - 1987*

A blues



0:00 VERSE

alternating 5th and 6th degrees on top . . . . .

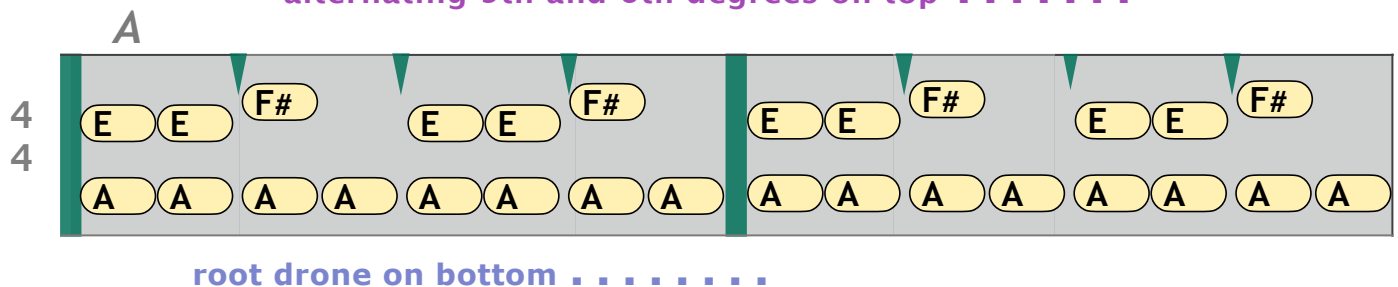

root drone on bottom . . . . .

This repeated bass pattern is usually heard today on electric guitar, but it originally came from the boogie woogie piano players of the 1910s and 20s. Bluesmen like Jimmy Yancey, “Pinetop” Smith, and Meade “Lux” Lewis pioneered the new boogie woogie sound, playing everywhere they could — from the city saloons of Chicago and St.Louis, to the backwoods lumber camps of the deep south.

Here’s an example of classic piano boogie woogie, recorded in 1939 by Pete Johnson. Listen to how the alternating 5, 6 bass pattern shifts up or down to follow each chord change of the standard 12 bar form.

*“Climbin’ and Screamin’ — Pete Johnson — 1939*

C blues



Boogie bass patterns like this eventually made the transition from piano to guitar, thanks to blues guitarists like Robert Johnson, who reportedly was an avid listener of piano blues. Legend has it that Johnson would drop the needle on his old Victrola and “record copy” the piano licks he heard. (This was the beginning of a long tradition among guitarists. Later guitar gods like Stevie Ray Vaughan would copy from Jimi Hendrix and Eric Clapton, who in turn copied from the recordings of bluesmen like Johnson.)

**"Sweet Home Chicago" – Robert Johnson – 1936**

F# blues



Robert Johnson was probably the first musician to record a song with this boogie bass on guitar, and his 1936 recording sounds remarkably modern. In fact, when listening to Johnson’s guitar, it doesn’t take much imagination to hear the beginnings of rock & roll.

By the time rock & roll finally did emerge in the 1950s, the boogie guitar pattern was so common that it became a defining element of the new style. Chuck Berry was especially fond of the boogie bass and used it to anchor many of his early hits, like this classic from 1958 :

**"Sweet Little Sixteen" – Chuck Berry – 1958**

Db blues



Elvis Presley’s 1957 recording “Too Much” features a single note version of the 5, 6 bass (shown below). Once again the pattern shifts to match the standard 12 bar chord changes.

**"Too Much" – Elvis Presley – 1957**

Ab blues



0:08 VERSE

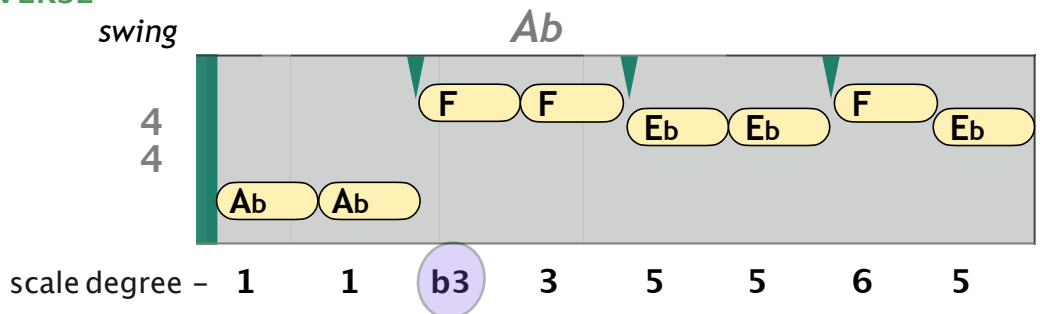

## Additional songs with BOOGIE BASS 5, 6

1957	<i>School Day</i>	Chuck Berry	G blues
1958	<i>Johnny B. Goode</i>	Chuck Berry	Bb blues
1960	<i>Stuck on You</i>	Elvis Presley	G blues
1960	<i>The Twist</i>	Chubby Checker (orig. Hank Ballard)	E blues
1970	<i>Key to the Highway</i>	Eric Clapton (orig. Segar / Broonzy)	A blues
1991	<i>Close to You</i>	Stevie Ray Vaughan	Ab blues
1994	<i>Forty Days and Forty Nights</i>	Tim McGraw	Bb blues
2021	<i>Not Dead Yet</i>	Lord Huron	F blues

(Pages 47 - 49 omitted from this sample)

## Signature Riffs

### HARMONIC FUNCTION RIFFS

One of the most famous rock riffs of all time turns out to be the blues in disguise. Listen closely to the iconic fuzz-tone riff of the Stones' "Satisfaction" and you'll recognize the traditional boogie 5, 6, b7 pattern. The riff is used without vocals in the intro, then disappears during the verse, but it returns to anchor the chorus, accompanying the vocals throughout the section.

**"Satisfaction" – Rolling Stones – 1965**

E blues



0:00 INTRO and CHORUS RIFF

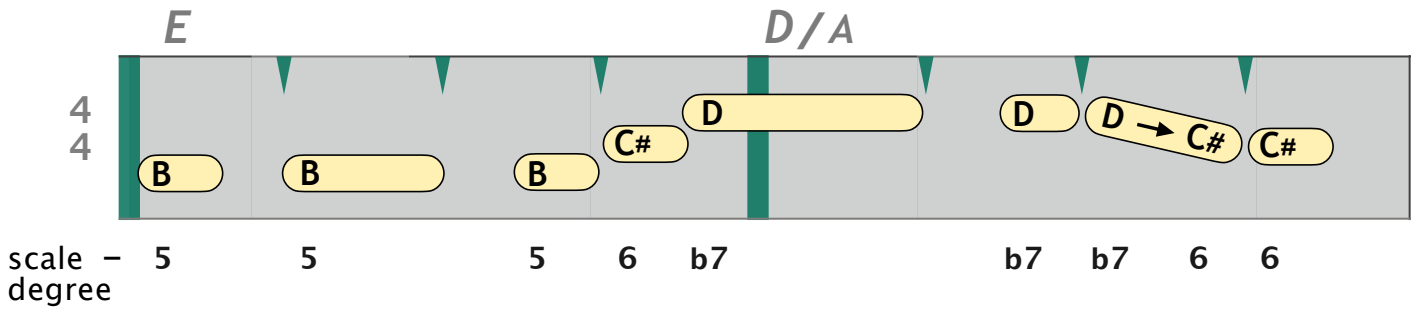

Here's another example of the signature riff introducing the song, then leaving during the verse, only to return in the chorus to highlight the title phrase. The guitar riff (shown below) is all minor pentatonic, with very brief upward string bends on most of the b3 notes (G naturals).

**"Life in the Fast Lane" – The Eagles – 1977**

E blues



0:00 INTRO and CHORUS RIFF

(E)

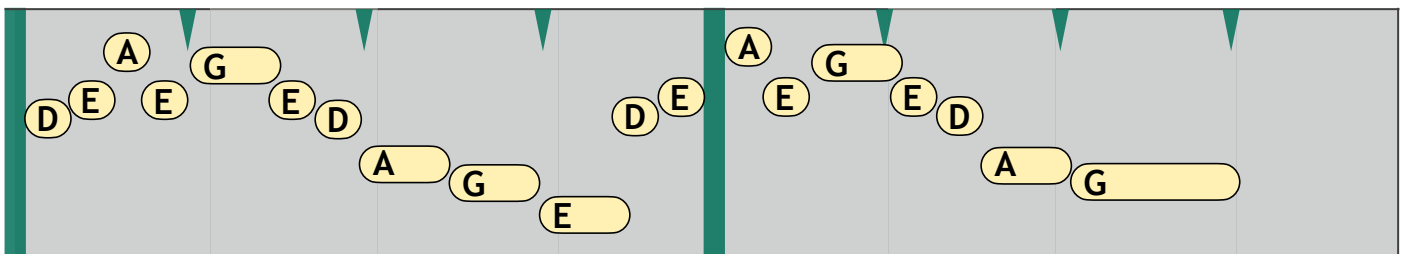
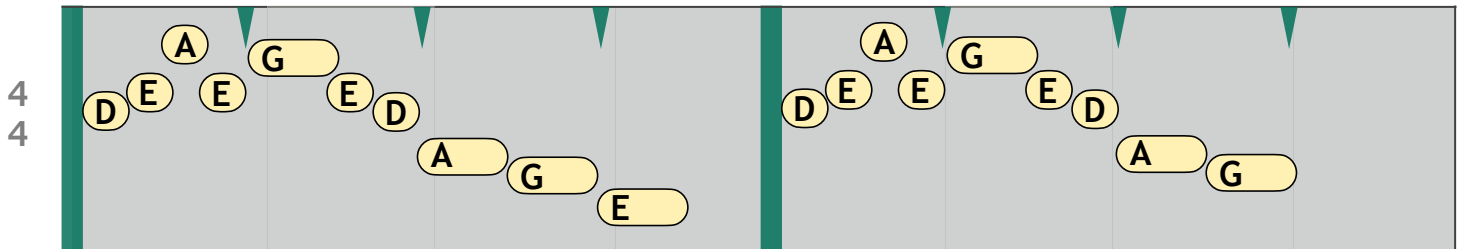

### Additional songs with HARMONIC FUNCTION RIFFS (blues)

1969	<i>How Many More Times</i>	Led Zeppelin	E blues
1970	<i>Funk #49</i>	James Gang	A blues
1972	<i>One Way Out</i>	Allman Brothers (org. S.B. Williamson)	A blues
2000	<i>Short Skirt, Long Jacket</i>	Cake	D blues
2019	<i>Eagle Birds</i>	Black Keys	E blues

(Pages 52 -54 omitted from this sample)

## Songwriting Focal Points

In this chapter’s songwriting section, we will look at two musical elements that have already been introduced earlier in the chapter — **stop time** and the **turnaround riff** — and discuss a little further how they are used to create focal points in the blues song “Seventh Son.” This song was written by noted bluesman Willie Dixon, and first recorded in 1955 by Willie Mabon. We will listen to the version made popular on the Top-40 charts in 1965 by artist Johnny Rivers. Let’s look first at how stop time is used in this song to create a focal point.

## Stop Time

As we heard earlier on several songs, the 12-bar blues form is sometimes split into a 4-bar verse and an 8-bar refrain, with stop time featured during the verse. In terms of songwriting, stop time can be a very effective way to create a focal point because the abrupt break in the song's instrumental flow obviously attracts attention and highlights the entrance of the refrain.

Johnny Rivers' "Seventh Son" provides a good example of a strong focal point generated by the 12-bar stop-time / refrain form. The first 3 bars feature a stop time sequence with an instrumental hit on beat one of each measure, creating some rhythmic tension. However, the last bar of the verse (bar 4) does not have the expected hit on the down beat, which only increases the tension heading into the refrain. Later in the song on verses 2, 3, & 4 (not shown), the stop time section is doubled to 8 bars.

**"Seventh Son" – Johnny Rivers – 1965**

E blues



I  
E

STOP TIME sequence . . . . . TENSION

0:10 VERSE

IV7  
A7

I7  
E7

RHYTHMIC RESOLUTION

0:17 REFRAIN (steady rhythm resumes)

V7  
B7

IV7  
A7

I7  
E7

V7  
B7

TENSION

TURNAROUND RIFF

0:30 VERSE 2 RESOLUTION



## 12-bar Blues Turnaround

You will notice that there is a second area of tension at the end of the refrain (bars 11 and 12) where the dominant V chord is added. Many blues songs include the V like this on the last measure of the repeating 12-bar form, which creates the familiar V to I focal point when the form starts over and resolves on the I chord. Adding to the strength of this hook is the descending turnaround riff (shown below). This turnaround is very similar to the riffs heard earlier on “Walkin’ Blues” and “Dust My Broom,” with descending scale notes b7, 6, b6, and 5.

The diagram illustrates a descending turnaround riff in 4/4 time. It is divided into two sections: the first section is labeled *E7* and the second is labeled *B7*. The notes are shown on a three-line staff with a 4/4 time signature on the left. The notes are: G# (first line), G# (second line), G (second space), G (second space), F# (first space), F# (first space), E (first space), and G# (first line). The notes are grouped into pairs: (G#, G#), (G, G), (F#, F#), and (E, G#). The *E7* section covers the first four measures, and the *B7* section covers the last four measures.

### 0:27 DESCENDING TURNAROUND RIFF - bars 11 and 12

With the completion of Chapter Four, we have introduced the three main pillars of pop and rock harmony — major, minor, and blues. This lays the foundation for virtually all the chapters that follow in this book. More will be said about blues tonality in Chapter Eleven when we further our discussion on blues-influenced songs.

To view the entire chapter, please purchase  
Membership access to the Learn Pop Theory site.

(See “Purchase” button in the middle of the home page for details)